

**PLEASE CHECK WWW.MOLEX.COM FOR LATEST PART INFORMATION**

**Part Number:** [39880-0906](#)  
**Status:** **Active**  
**Overview:** Eurostyle™ Terminal Blocks  
**Description:** 5.08mm Pitch Beau™ Eurostyle™ Medium Profile, Three Level Terminal Block, Modular, 6 Circuits

**Documents:**

[3D Model](#) [RoHS Certificate of Compliance \(PDF\)](#)  
[Drawing \(PDF\)](#)

**Agency Certification**

UL E48521

**General**

Product Family Terminal Blocks  
 Series [39880](#)  
 Application N/A  
 Component Type One Piece  
 Overview [Eurostyle™ Terminal Blocks](#)  
 Product Name Eurostyle™ Multi-Level  
 Type Euro Block  
 UPC 800756363332

**Physical**

Circuits (Loaded) 6  
 Entry Angle Horizontal  
 Flammability 94V-0  
 Lock to Mating Part None  
 Number of Rows 3  
 Orientation Vertical  
 PC Tail Length 3.80mm  
 PCB Retention None  
 PCB Thickness - Recommended 2.60mm  
 Panel Mount No  
 Pitch - Mating Interface 5.08mm  
 Pitch - Termination Interface 5.08mm  
 Polarized to Mating Part N/A  
 Shrouded Fully  
 Stackable Yes  
 Temperature Range - Operating 110°C  
 Wire Size AWG 12, 14, 16, 18, 20, 22, 24, 26, 28, 30  
 Wire Size mm² 0.05 - 2.50

**Electrical**

Current - Maximum per Contact 17.5A  
 Voltage - Maximum 300V

**Solder Process Data**

Lead-free Process Capability Wave Capable (TH only)

**Material Info**

Old Part Number 883206

**Reference - Drawing Numbers**

Sales Drawing SD-39880-009

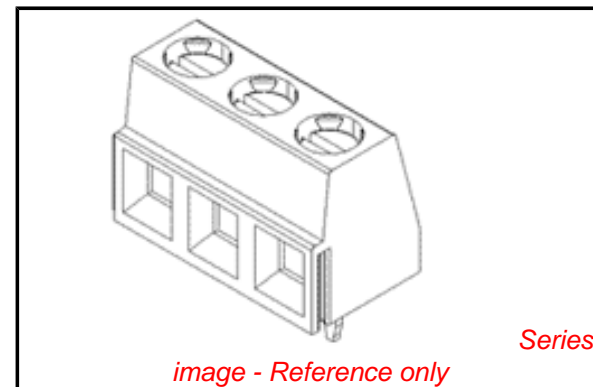

**EU RoHS**

**ELV and RoHS  
Compliant**  
**REACH SVHC**  
 Not Reviewed  
**Low-Halogen Status**  
 Not Reviewed

**China RoHS**



**Need more information on product  
environmental compliance?**

Email [productcompliance@molex.com](mailto:productcompliance@molex.com)  
 For a multiple part number RoHS Certificate of Compliance, [click here](#)

Please visit the [Contact Us](#) section for any non-product compliance questions.

**Search Parts in this Series**

[39880Series](#)

This document was generated on 12/22/2014

**PLEASE CHECK [WWW.MOLEX.COM](http://WWW.MOLEX.COM) FOR LATEST PART INFORMATION**